

# User manual Ironers

IC63316 – IC63320

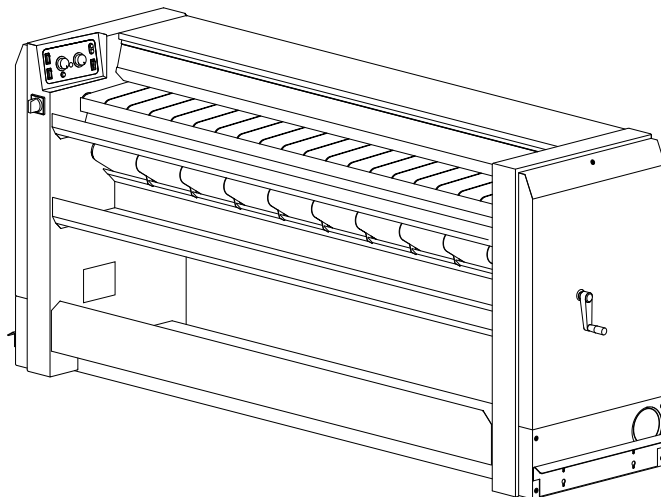

Originals instructions



**Electrolux**  
PROFESSIONAL



# Contents

---

## Contents

1	Precaution for use .....	5
2	Safety rules.....	5
3	Warranty terms and exclusions.....	6
4	General .....	6
4.1	Data plate explanation.....	7
5	Method of use .....	10
5.1	Standard control panel .....	10
5.2	Starting machine with standard control panel .....	11
5.3	Stopping machine with standard control panel.....	11
5.4	DIAMMS control panel .....	12
5.5	Simplified instructions for using the ironer with DIAMMS option .....	13
5.6	Starting machine with DIAMMS console .....	16
5.7	Cooling mode with DIAMMS console.....	17
5.8	Automatic mode with DIAMMS console .....	17
5.9	Manual mode with DIAMMS console .....	18
5.10	Service screen in automatic mode with DIAMMS console .....	18
5.11	Service screen in manual mode with DIAMMS console .....	19
5.12	Stopping the machine with DIAMMS console .....	19
5.13	Complementary instructions for starting up a machine with gas heating .....	19
5.14	Complementary instructions for starting up a machine with electrical heating.....	19
6	Use .....	19
6.1	Instructions to optimise a dryer-ironer .....	19
6.2	Precautions for use .....	20
6.3	Practices to avoid .....	21
6.4	Practices not recommended .....	21
6.5	Cautions .....	21
6.6	Using the handle.....	21
6.7	Using the tipping feed bin .....	22
7	Use recommendations.....	22
8	Safety devices .....	23
8.1	Complementary instructions for operation.....	24
9	Operating faults.....	24
9.1	Static electricity.....	25
9.2	Linen colouring .....	25
9.3	The feed bands are not turning .....	25
9.4	Complementary instructions for starting up a machine with gas heating.....	25
9.5	Overheating of cylinder sides.....	26
9.6	Overheating of centre of cylinder.....	26
9.7	Converter fault.....	26
9.8	Fault Emergency stop .....	27
9.9	Gas burner ignition fault (only for machines using gas heating).....	27
9.10	Reset the igniter (only for machines using gas heating).....	27
9.11	Fault with the heating system.....	28
10	Maintenance .....	28
10.1	Check of the detaching cords or pressure roller : .....	30
10.2	Replacing ironing bands.....	30
10.3	Components with maintenance .....	31
11	Symbols .....	33
12	Lubricant table .....	34
13	Explanation of washing symbols.....	35
13.1	Washing.....	35
13.2	Bleaching.....	35
13.3	Drying .....	36
13.4	Ironing .....	36
13.5	Dry or water cleaning .....	36



## 1 Precaution for use

- The machine should not be used by children.
- Blankets should not be ironed.
- This ironer must be used exclusively for textiles appropriate for machine ironing, which have been previously and exclusively washed in water.
- Be careful with synthetic linen and also with printed linen. They can melt and stick on the cylinder.
- Do not iron articles that contain plastic, foam, sponge rubber or similarly textured rubberlike materials.
- Do not iron linens coated with solvent, paint, wax, grease or any easily inflammable products.

## 2 Safety rules

- Before any use, it is compulsory to read the instruction handbook.
- Users must have learnt how the machine operates.
- When ironing, do not wear loose or billowing garments (e.g. wide sleeves, ribbons, ties, etc...).
- Never iron if the hand protection bar is not operating.
- Do not iron linens coated with solvent, paint, wax, grease or any easily inflammable products.
- Do not put your hands between the raised bed and the cylinder to adjust or smooth out linen.
- Never smooth out linen by holding on to the inner corners of quilt covers, pillow cases, the shoulder straps of underwear or any other straps. Do not put your hands in the pockets of clothing.
- To prevent the risk of fire or explosion, never use flammable products to clean the machine.



### Caution



For your personal safety, never use the machine without the protective housings.

### 3 Warranty terms and exclusions

If the purchase of this product includes warranty coverage, warranty is provided in line with local regulations and subject to the product being installed and used for the purposes as designed, and as described within the appropriate equipment documentation.

Warranty will be applicable where the customer has used only genuine spare parts and has performed maintenance in accordance with Electrolux Professional user and maintenance documentation made available in paper or electronic format.

Electrolux Professional strongly recommends using Electrolux Professional approved cleaning, rinse and descaling agents to obtain optimal results and maintain product efficiency over time.

The Electrolux Professional warranty does not cover:

- service trips cost to deliver and pick up the product;
- installation;
- training on how to use/operate;
- replacement (and/or supply) of wear and tear parts unless resulting from defects in materials or workmanship reported within one (1) week from the failure;
- correction of external wiring;
- correction of unauthorized repairs as well as any damages, failures and inefficiencies caused by and/or resulting from;
  - insufficient and/or abnormal capacity of the electrical systems (current/voltage/frequency, including spikes and/or outages);
  - inadequate or interrupted water supply, steam, air, gas (including impurities and/or other that does not comply with the technical requirements for each appliance);
  - plumbing parts, components or consumable cleaning products that are not approved by the manufacturer;
  - customer's negligence, misuse, abuse and/or non-compliance with the use and care instructions detailed within the appropriate equipment documentation;
  - improper or poor: installation, repair, maintenance (including tampering, modifications and repairs carried out by third parties not authorized third parties) and modification of safety systems;
  - Use of non-original components (e.g.: consumables, wear and tear, or spare parts);
  - environment conditions provoking thermal (e.g. overheating/freezing) or chemical (e.g. corrosion/oxidation) stress;
  - foreign objects placed in- or connected to- the product;
  - accidents or force majeure;
  - transportation and handling, including scratches, dents, chips, and/or other damage to the finish of the product, unless such damage results from defects in materials or workmanship and is reported within one (1) week of delivery unless otherwise agreed;
- product with original serial numbers that have been removed, altered or cannot be readily determined;
- replacement of light bulbs, filters or any consumable parts;
- any accessories and software not approved or specified by Electrolux Professional.

Warranty does not include scheduled maintenance activities (including the parts required for it) or the supply of cleaning agents unless specifically covered within any local agreement, subject to local terms and conditions.

Check on Electrolux Professional website the list of authorized customer care.

### 4 General

In the machine you should have found a set of instructions and a servicing poster to display in your laundry.

You must have found with this handbook, a crank for the manual drive of the cylinder.

Depending on its destination, the dryer ironer is delivered bare or may be placed on a transport pallet and/or packed with plastic film.

In some cases, it may be delivered in maritime packing (wood crate).

Please refer to the handling chapter in this installation handbook for a description of handling operations.

Before any use, it is compulsory to read the instruction handbook.

Users must have learnt how the machine operates.

This manual describes a heated ironer, available in 1 m 60, 2.00 m ironing widths.

This ironing machine is also available with a coin operating system.

The ironing machines are supplied with an evacuation system.

The ironing speed can be adjusted according to the linen texture and its degree of moisture.

The temperature of the ironing cylinder can also be adjusted by a thermostat.  
The parameters are displayed by a control panel.



### Caution



This machine should be installed in conformance to the health and safety regulations, and only used in a sufficiently aerated area.  
**Check the instructions before installing or using the machine.**

### Note!

**This machine contains no asbestos.**

The identification plate is situated on the left side.

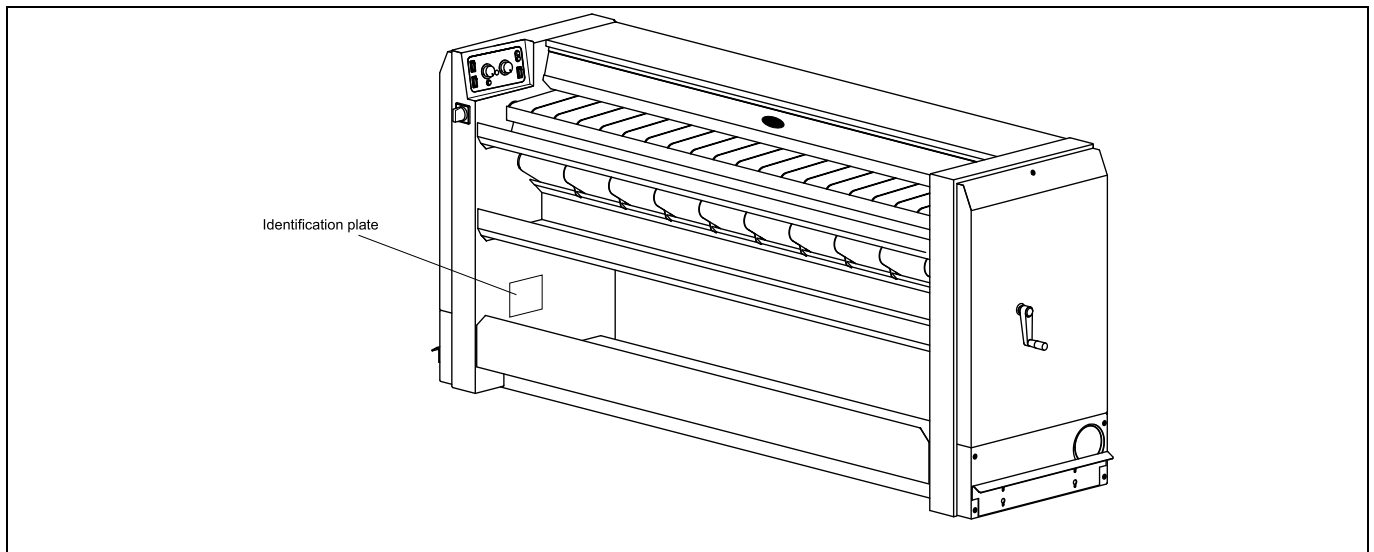

## 4.1 Data plate explanation

In this chapter, you will find the explanation of the different data input on the data plate of your product.

- Commercial name : Usual name of your product ( i.e. IC43320).
- Type : Type of your product (you have the same on the Declaration of Conformity CE if delivered with CE certification).
- Model : Model of your product (can be different of commercial name ) .
- Serial Number : serial number of your product which indicate the week of the production of your product (the first 4 digit indicate the year and the week of production) and the plant where it has been produced (finish by 17)
- Product N°: Product number of your product.
- Date : The date of the end of manufacture of your product
- Some technical data depending of the heating of your product : see list below :
- Some technical data depending of the voltage ordered.  
the voltage looks like that 380–415V 3 50–60Hz  
under this, you find the protection request for your product (i.e 16 A)
- Different logos are available on your data plate .  
They represent the different certification obtained for your product  
CE, EAC  
ETL intertek for USA and Canada countries
- QR code : when you scan it, you will be able to obtain the full documentation for your product (Complete installation and user manuals)
- Standardized protection index of your product : IP24D

## Electrical heating :

- P.Max : maximum power installed of your product
- Power of the motorization in kW and its isolation class (F) .
- Heating power in W .

Commercial name : IC43320  
 Product N° : 9882800210F  
 Serial N° : 4032002017  
 Type : IC43320



Date : 22/02/2024

Electrolux Professional Laundry Systems France 10430 Rosières-près-Troyes - FRANCE



Commercial name : IC43320  
 Type : IC43320  
 Model : IC43320

Serial N° : 4032002017  
 Product N° : 9882800210F  
 Capacity : - kg  
 P.Max : 23000 W

0.37 kW Isol.Class. : F

22500 W

380-415 V 3 50-60 Hz

40 A

For safety reasons use only original spare parts.



IP24D Date : 22/02/2024

Made in France by  
 Electrolux Professional Laundry Systems France  
 10430 Rosières-près-Troyes - FRANCE



32101642E

Commercial name : IC43320  
 Product N° : 9882800210F  
 Serial N° : 4032002017  
 Type : IC43320



Date : 22/02/2024

Electrolux Professional Laundry Systems France 10430 Rosières-près-Troyes - FRANCE





**Gas heating :**

Left side

- P.Max : maximum power installed of your product
- Power of the motorization in kW and its isolation class (F) .
- Heating power in W .
- Gas approval number depending on your machine except ETL product (begin by1312/.....)

Right side

- Qn (Hi) : heating power of your product
- Installed gas type , its pressure, its injector diameter and its consumption .
- Gas type for approval
- 3 Other gas type compatible with their pressure, their injectors diameter

Commercial name : IC43320  
 Product N° : 9882810210F  
 Serial N° : 3512000617  
 Type : IC43320



Electrolux Professional Laundry Systems France 10430 Rosières-près-Troyes - FRANCE



Commercial name : IC43320  
 Type : IC43320  
 Model : IC43320



Serial N° : 3512000617  
 Product N° : 9882810210F  
 Capacity : - kg  
 P.Max : 500 W

Gas Settings Factory  
 Qn(Hi) 25 kW  
 Natural Gas, G20 20 mBar, Ø 2,7 mm.  
 Mn/Vn 2.64 m3/h  
 Type FR.II2Esi3+

Ⓜ 0.37 kW Isol.Class. : F  
 25 W  
 380-415 V ~ 3 50-60 Hz  
 12 A

Other Gas Options  
 Natural Gas, G25 25 mbar Ø 2,7 mm.  
 LPG, G30 30 mbar Ø 1,5 mm.  
 LPG, G31 37 mbar Ø 1,5 mm.

For safety reasons use only original spare parts.



IP24D Date : 19/01/2024

Made in France by  
 Electrolux Professional Laundry Systems France  
 10430 Rosières-près-Troyes - FRANCE



32101642E

Commercial name : IC43320  
 Product N° : 9882810210F  
 Serial N° : 3512000617  
 Type : IC43320



Electrolux Professional Laundry Systems France 10430 Rosières-près-Troyes - FRANCE



## 5 Method of use

### 5.1 Standard control panel

1. "Voltage" indicator
2. "Stop" switch
3. "On" switch
4. "Ironing speed adjustment" potentiometer
5. "Ironing temperature selection" thermostat
6. "Heating" indicator on
7. Gas heating "Ignitor failure" indicator
8. "On / Off" heating switch with "On" indicator
9. "Automatic stop" zone

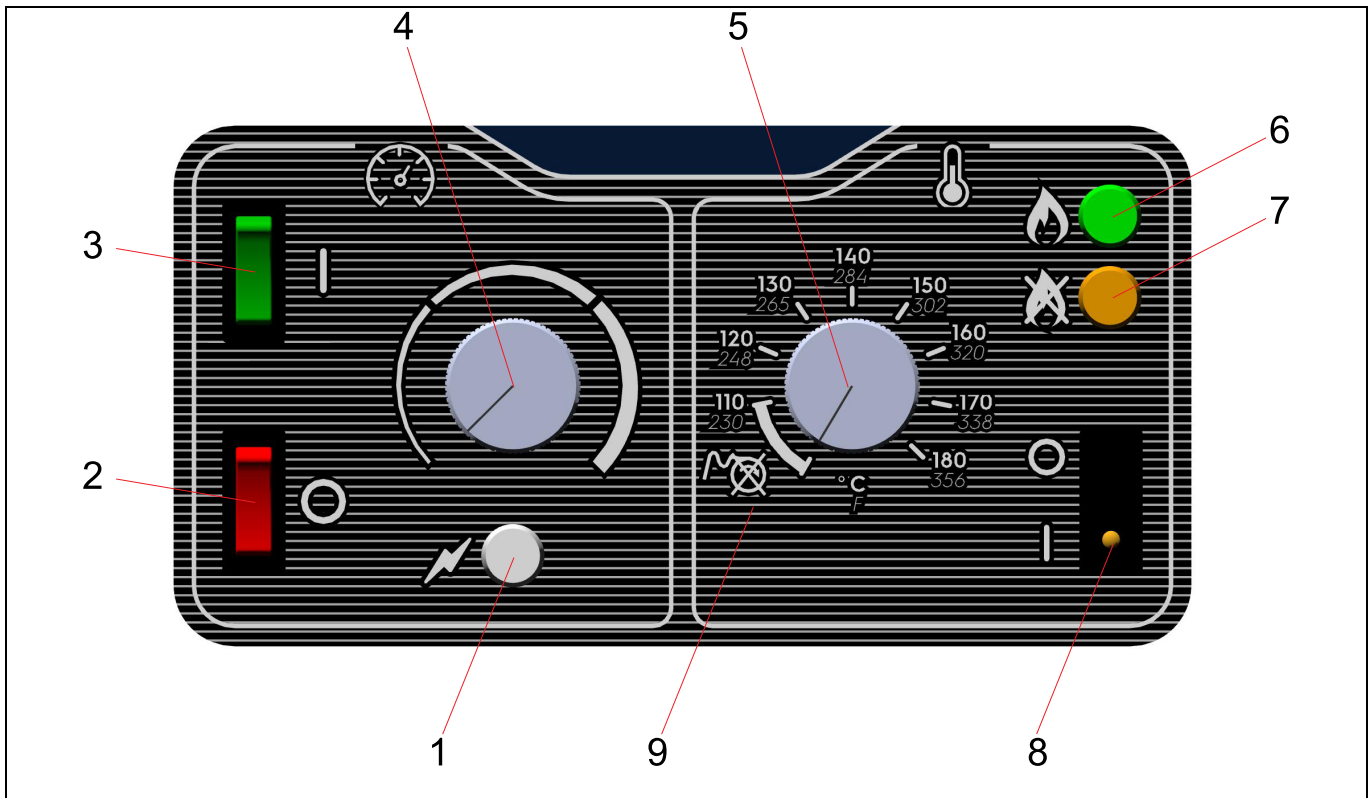

## 5.2 Starting machine with standard control panel

- Turn main section switch to I (ON), the indicator (1) "**voltage**" lights".
- Turn the potentiometer (4) to the minimum speed.
- Adjust thermostat (5) on required temperature. Usual ironing temperature is around 180 °C (355 °F) for cotton.
- Press button (3) "**On**".

The cylinder and the guiding bands rotate.

The fan works and draws the air out of the machine to outside the building.

- Press switch (8) "**heating on**", the key indicator lights. The heating indicator (6) lights. The temperature rise is reached after approximately 12 min for a temperature of 180 °C (355 °F). The heating indicator (6) switches off as soon as the required ironing temperature is reached.

- Check that the finger protection is working. The finger protection must stop the machine when it is touched.

Press button (3) "**On**" to restart the machine.

- Adjust potentiometer (4) on an average speed and start ironing.
- Adjust the ironing speed depending on the textile processed and the moisture rate of the linen.
- If the pipe burner is secured, the indicator (6) switches off and the indicator (7) lights ; (to restart the machine, press "STOP HEATING" and then "HEATING ON" (8).

## 5.3 Stopping machine with standard control panel

- In order to extend the lifetime of your machine and its components, observe the following instructions to stop the heating.

- Press switch (6) "**Heating stop**", its indicator switches off. The "**Heating**" indicator (8) switches off too.
- Set the temperature setting button to minimum.
- Continue to feed in damp laundry until the temperature of the cylinder no longer produces satisfactory drying.
- The machine stops automatically when the temperature falls sufficiently low.
- Turn the general switch situated on the left casing to O (off).

**CAREFUL** : At any time, it is possible to stop the machine by pressing key (2) "**General stop**", a high temperature of the ironing cylinder may damage the ironing strips.

## 5.4 DIAMMS control panel

1.This indicator lights up when the linen removed from the dryerironer is not completely dry.



2.Display screen

3.Functions keys :

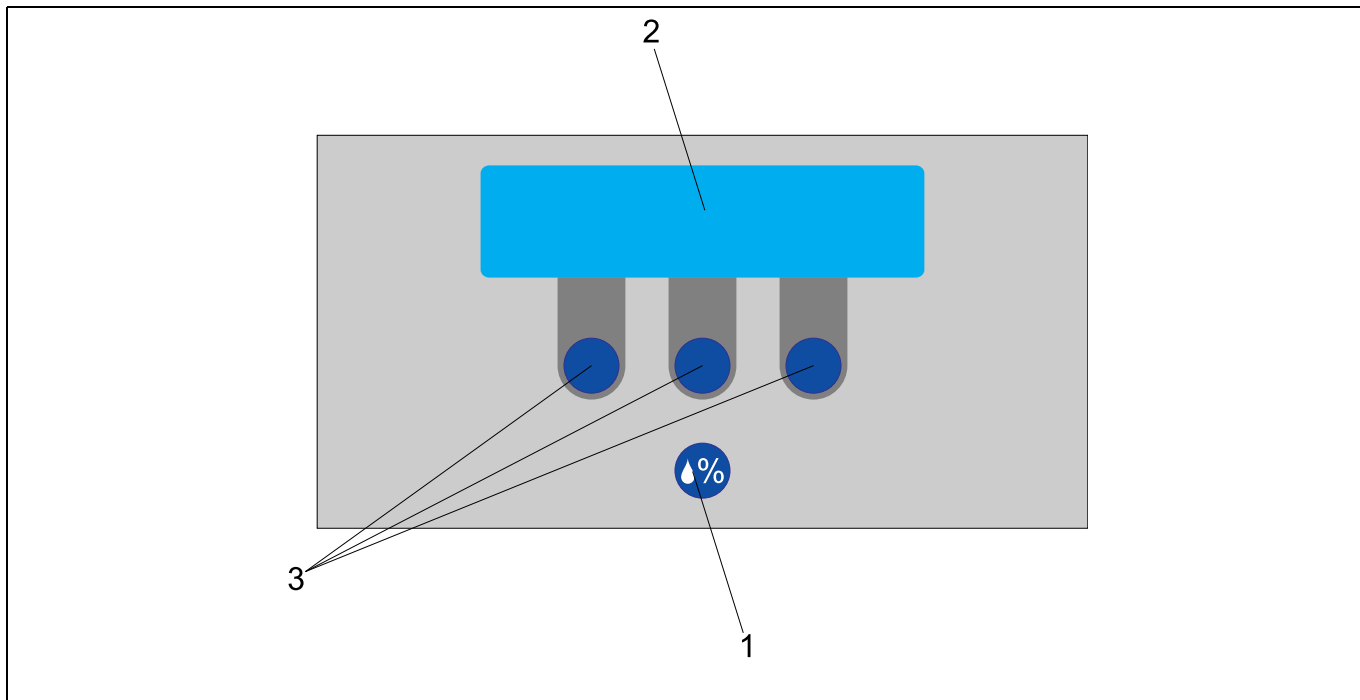
Function key assignments vary according to the menu displayed on the screen during operation



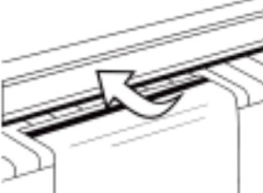
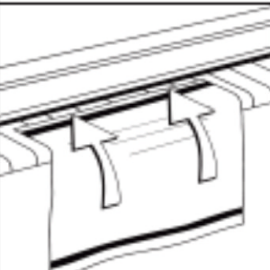

5.5 Simplified instructions for using the ironer with DIAMMS option

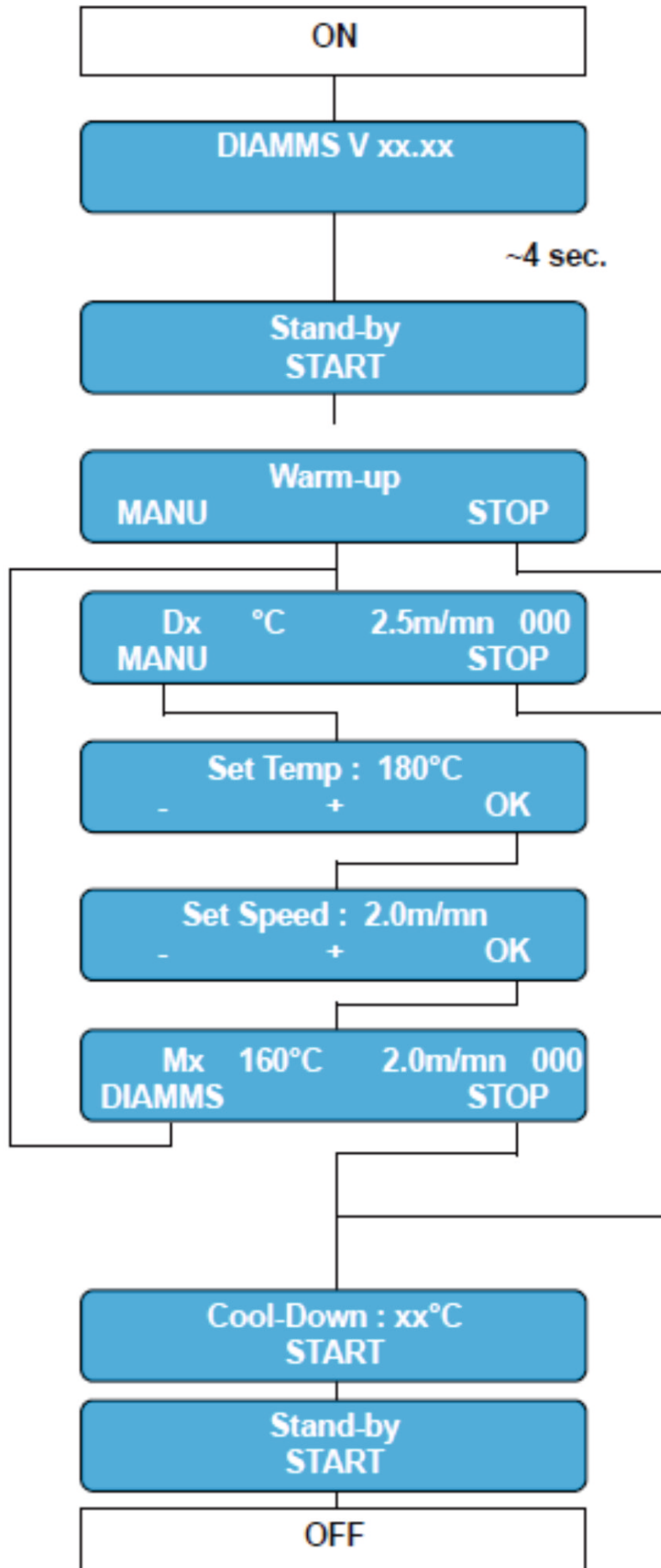
<h1>1</h1>	<p>Switch on the main switch, open the gas stop valve.</p> 	<p>Wait for displaying of the following message and press the central key.</p> <div style="border: 1px solid black; background-color: #00AEEF; color: white; padding: 5px; text-align: center; width: fit-content; margin: 0 auto;">                 Stand by START             </div>	<p>When it begins operating, the machine is set to «automatic mode». You can now insert sheets.</p> <div style="border: 1px solid black; background-color: #00AEEF; color: white; padding: 5px; text-align: center; width: fit-content; margin: 0 auto;">                 Dx °C 2.5m/mn 000 MANU STOP             </div>
<h1>2</h1>	<p><b>Manual Mode :</b> Adjust the order temperature on the wished value thanks to keys (-) or (+) and push on OK.</p> <div style="border: 1px solid black; background-color: #00AEEF; color: white; padding: 5px; text-align: center; width: fit-content; margin: 0 auto;">                 Set Temp : 180°C - + OK             </div>	<p><b>Manual Mode :</b> Adjust the ironing speed on the wished value thanks to keys (-) and (+) and push on OK.</p> <div style="border: 1px solid black; background-color: #00AEEF; color: white; padding: 5px; text-align: center; width: fit-content; margin: 0 auto;">                 Set Speed : 2.0 m/mn - + OK             </div>	
<h1>3</h1>	<p><b>Safety :</b> The machine must stop when the mobile safety protector (hand safety) is switched on. Check operation of this protection every day.</p> 	<p><b>Ironing :</b> Place the washing to be ironed on the feeding table.</p> <div style="border: 1px solid black; background-color: #00AEEF; color: white; padding: 5px; text-align: center; width: fit-content; margin: 0 auto;">                 Error Gas Ignition             </div>	
<h1>4</h1>	<p><b>Ignition fault on gas heating machine :</b> This message keeps on flashing over 30 seconds if a fault occurs when igniting the gas burner.</p>		
<h1>5</h1>	<p><b>Stopping the machine :</b> Push on any key to display "Select Running Mode" and push on STOP. Do not use the folding function during the cooling phase. Leave the machine cool down until the following message has disappeared. In an emergency, pressing the hand safety bar will stop the machine.</p> <div style="border: 1px solid black; background-color: #00AEEF; color: white; padding: 5px; text-align: center; width: fit-content; margin: 0 auto;">                 Cool-Down : xx°C START             </div>	<p>Switch the main switch off, close the gas stop valve.</p> 	





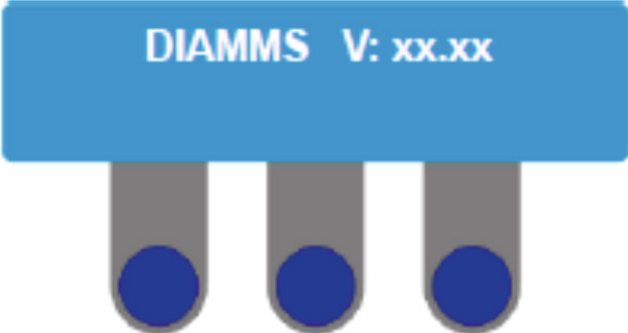

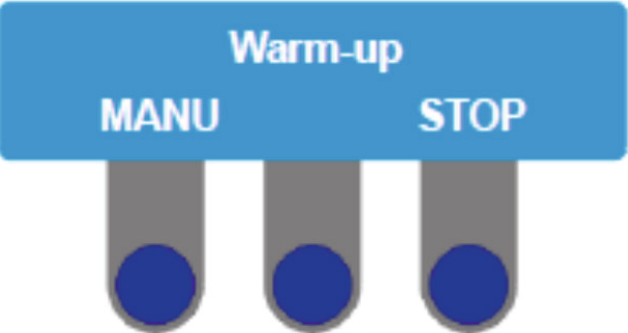
## 5.6 Starting machine with DIAMMS console

 <p>The image shows a blue rectangular screen with the text "DIAMMS V: xx.xx" in white. Below the screen are three vertical grey bars, each with a blue circle at the bottom, representing touch-sensitive buttons.</p>	<p><b>Start-up screen</b> Turn on the power to the machine using the machine's main switch. The software version will appear on the screen for 4 seconds.</p>
 <p>The image shows a blue rectangular screen with the text "EMERGENCY STOP" and "RESET PUSH BUTTON" in white. Below the screen are three vertical grey bars, each with a blue circle at the bottom, representing touch-sensitive buttons.</p>	<p><b>"Emergency stop" warning message</b> If the screen displays this message, check whether the emergency stop button has been operated. Reset the emergency stop button and confirm by pressing the central key. In all cases, you will return to the previous menu.</p>
 <p>The image shows a blue rectangular screen with the text "Stand by" and "START" in white. Below the screen are three vertical grey bars, each with a blue circle at the bottom, representing touch-sensitive buttons.</p>	<p><b>Accessing the start-up menu</b> The machine now asks you to press the central key to exit standby mode so as to display the pull-down menus and select the machine's operating modes.</p>
 <p>The image shows a blue rectangular screen with the text "Warm-up" at the top, "MANU" on the left, and "STOP" on the right. Below the screen are three vertical grey bars, each with a blue circle at the bottom, representing touch-sensitive buttons.</p>	<p><b>Warm-up</b> As soon as the machine is turned on, the «Start heating» command is given. The cylinder temperature begins to rise. By default, the machine is set for automatic mode. The service screen appears as soon as the sheets have been inserted or when the required temperature s reached.</p>



## 5.7 Cooling mode with DIAMMS console

	<p><b>Cooling mode</b> When the <b>STOP</b> function is requested during operation, the machine will switch to standby and the heating system will be switched off. The screen will remain in this mode as long as the temperature of the cylinder remains above 100°C (212°F).</p>  <p>You can now switch off the machine.</p>
---	---

## 5.8 Automatic mode with DIAMMS console

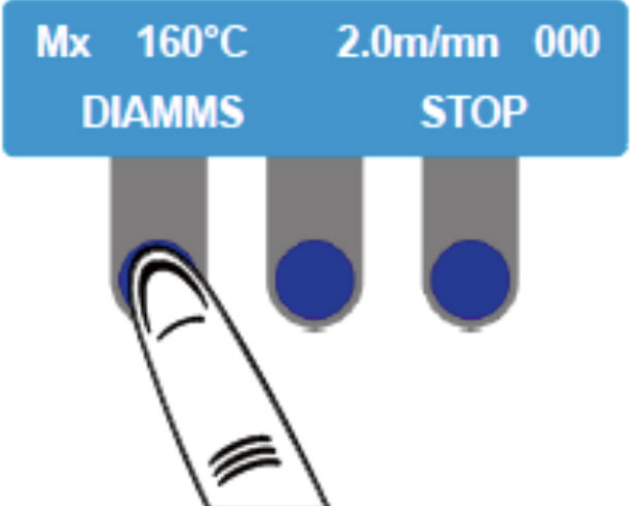
	<p><b>Selection of the automatic mode</b> When it starts up, the machine is set for automatic mode by default. However, you can switch over to manual mode at any time. The «M» in the upper left-hand corner shows that you are in manual mode. To return to automatic mode, all you need to do is to press once on the «DIAMMS» button. <b>Each changeover from manual mode to automatic mode automatically resets the sheet counter.</b></p>
--	---

## 5.9 Manual mode with DIAMMS console

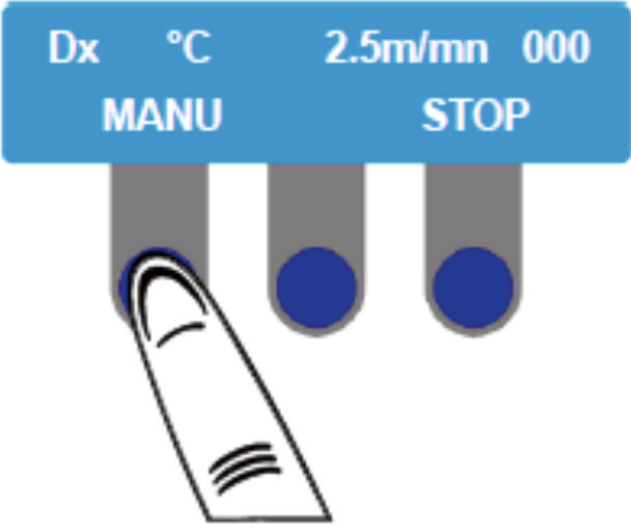
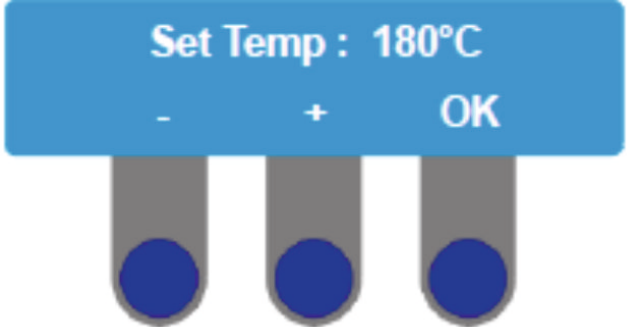
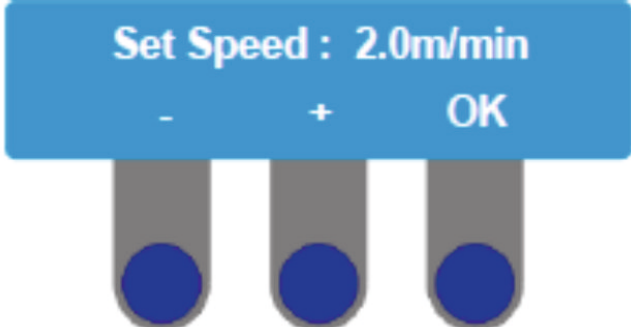
	<p><b>Selection of Manual mode</b></p> <p>If you press <b>MANU</b>, you will switch to manual mode. In this mode you use the following menus to select the temperature and the ironing speed you wish to apply to the machine. <b>Each changeover from manual mode to automatic mode automatically resets the sheet counter.</b></p>
	<p><b>Temperature setting</b></p> <p>The screen will now ask you to set the ironing temperature. The ironing temperature can be adjusted in increments of 5 degrees Celsius (or 9 degrees Fahrenheit) by pressing. Press <b>OK</b> to confirm the temperature.</p> <p><b>Note: if you request a temperature lower than 120°C (248°F), the screen will display a (-) sign to indicate that the heating has been switched off and allow the machine to operate without heating.</b></p>
	<p><b>Ironing speed setting</b></p> <p>The screen now ask you to select the ironing speed. The ironing speed can be set between a minimum and a maximum value specified in the Settings menu. The value can be adjusted in increments of 1/10 of a meter (or 3/10 of an inch) by pressing. Press <b>OK</b> to confirm the ironing speed.</p> <p>It should be noted that the minimum and maximum ironing values depend on the converter adjustment settings.</p>

## 5.10 Service screen in automatic mode with DIAMMS console

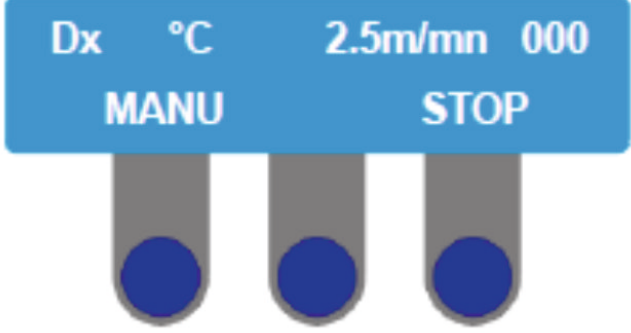
	<p><b>Service screen in automatic mode</b></p> <p>The values for the current use of the machine are shown on the first line of the screen.</p> <ul style="list-style-type: none"> <li>• The «D» shows that you are in automatic mode (DIAMMS)</li> </ul> <p>The two following values show:</p> <ul style="list-style-type: none"> <li>• The ironing speed</li> <li>• The sheet counter information</li> </ul> <p>In automatic mode (<b>DIAMMS</b>), the cylinder temperature will not be displayed. This is managed by the machine itself. Only the flashing «°C» indicator is shown.</p> <p>The second line displays the commands accessible from the buttons on the panel.</p>
--	--

### 5.11 Service screen in manual mode with DIAMMS console

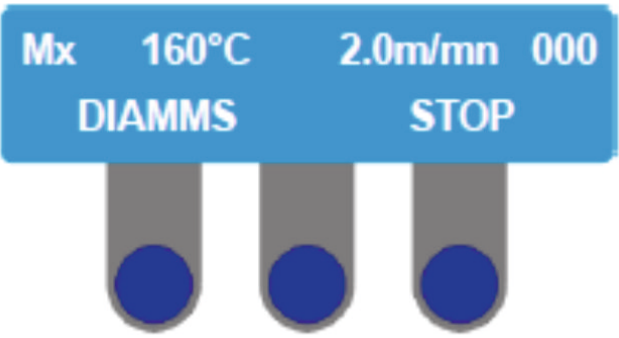
	<p><b>Service screen in Manual mode</b></p> <p>The first line of the screen displays the values for the current use of the machine.</p> <ul style="list-style-type: none"> <li>• The «M» shows that you are in manual mode.</li> </ul> <p>The following three values show:</p> <ul style="list-style-type: none"> <li>• The current cylinder temperature</li> <li>• The ironing speed</li> <li>• The sheet counter information</li> </ul> <p>Various indications regarding the temperature of the ironing cylinder are displayed:</p> <ul style="list-style-type: none"> <li>• A flashing "T" indicates that the machine is in the process of heating.</li> <li>• A (-) sign after the "T" indicates that the temperature of the cylinder is below 100°C (212°F).</li> <li>• The current temperature is displayed when the temperature of the cylinder is between 101°C and 245°C (213°F and 470°F).</li> </ul> <p>Note : values 101-245°C are minimum and maximum temperature that the electronic programmer can display. The maximum ironing temperature cannot reach 245°C (470°F), a safety thermostat automatically cuts off heating before reaching this value.</p> <ul style="list-style-type: none"> <li>• A (+) sign after the "T" indicates that the temperature of the cylinder is above 245°C (470°F).</li> </ul> <p>The second-line displays the commands accessible from the buttons on the panel.</p>
---	--

### 5.12 Stopping the machine with DIAMMS console

Please respect the following instructions when switching off the heating, to ensure that your machine and its components last for a long time.

- Use the **STOP** function on control panel to stop the machine.
- When the screen displays "**Stand by/Start**", switch the main switch to the "OFF" position.
- Close the gas inlet valve.

You can switch the machine off at any time by pressing on the machine stop switch; but note that if the ironing cylinder is too hot (above 120 °C (248 °F), it can damage the bands.

### 5.13 Complementary instructions for starting up a machine with gas heating

The ignition of the burner is delayed by 30 seconds following the start command in order to allow for the pre-ventilation of the combustion chamber.

The machine will be ready for use after the message has disappeared : "**Error Gas Ignition**".



#### Important



**The noise at the inter-ignition is not an explosion. It is a normal phenomenon.**

### 5.14 Complementary instructions for starting up a machine with electrical heating

The typical ironing temperature is 150 to 180 °C (300 °F to 356 °F). You just have to set the electronic thermostat to the required temperature.

In automatic mode, the ironing temperature is defined and managed by the machine.

## 6 Use

### 6.1 Instructions to optimise a dryer-ironer.

When ironing small sheets or small washing, pass abreast the washing of the heating cylinder to provide correct regulation of the cylinder temperature.

As a general rule, the whole of the cylinder should be used (1). Either iron the linen from the front (2) or iron alternately (3), which makes maximum use of the heat units available over the surface of the cylinder. It also overcomes difficulties arising from random control values caused by partial use of the cylinder.

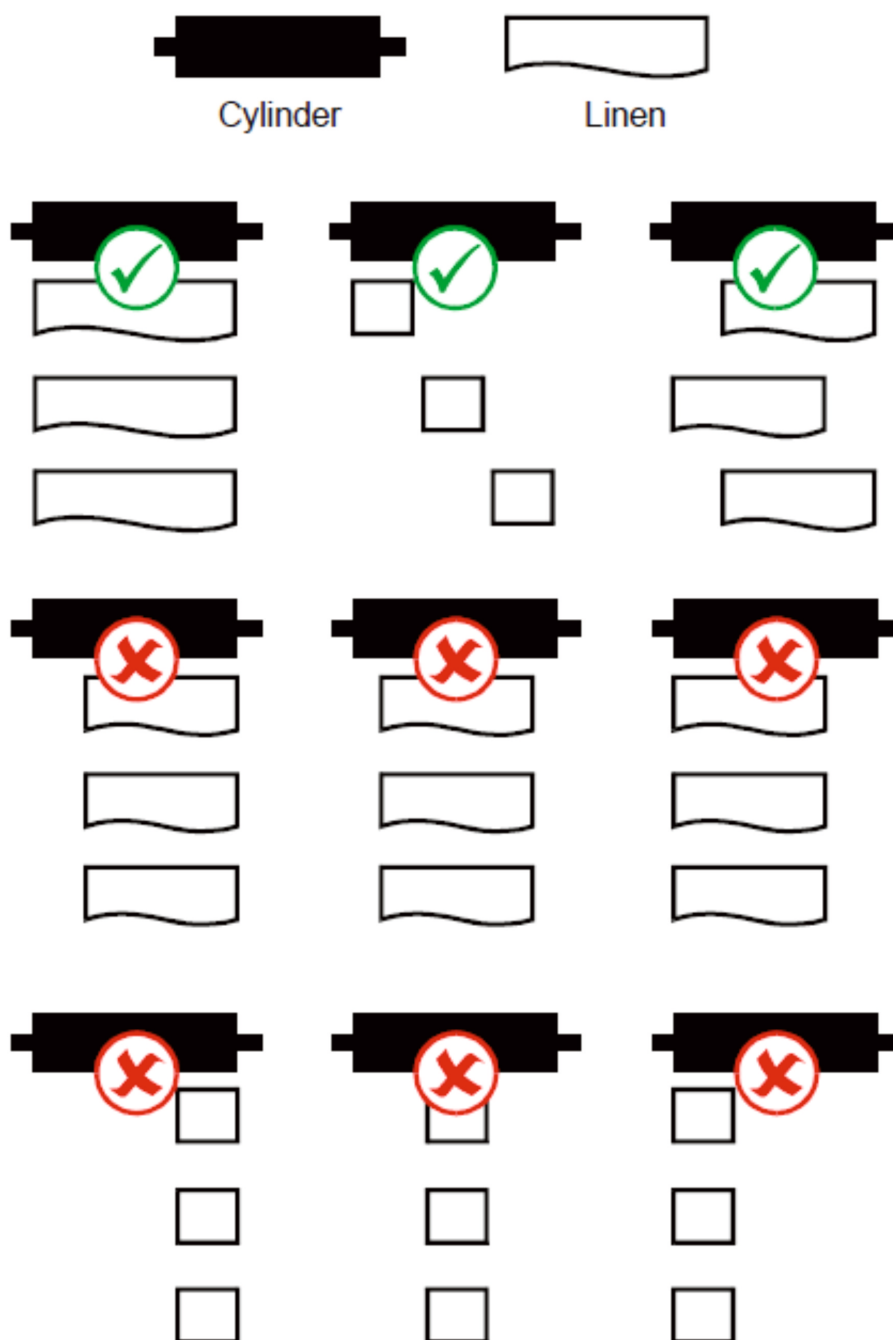

## 6.2 Precautions for use

Please respect the following usage recommendations to get the best out of your ironer:

In manual mode

- Avoid when running, too low or badadjusted temperatures as consequence of :
  - a too high ironing speed with high moisture content in sheets : bad sliding on metallic sparts.
  - a partial use of the ironing length of the cylinder : creating overheating (be carreful especially, to the risk for the poly-cotton sheets to loose their shape, generally stabilised at 200 °C (392 °F).
- You should begin ironing when the «**Warming up**» message disappears.
- Check that the washing can be ironed and check the temperature at which it is to be ironed.

The productivity and quality of ironing depend on the washing quality ; make sure that all these conditions are satisfied.

- We recommend as far as possible, that you should feed pieces of flat washing (towels, sheets, etc.) by their hem, with the seam facing top, to obtain maximum ironing quality.

- Carefully engage the washing to be ironed, because it is impossible to disengage a badly engaged washing.
- Do not iron washing folded in four, because it will be too thick to achieve the drying/ironing/folding quality that you are entitled to expect from your machine.
- If possible, use the entire ironing width of the dryer ironer.

**6.3 Practices to avoid**

- Make sure that the width of the washing does not exceed the useful width of the machine.
- Sizes not fitting the cylinder working length, partial use of the cylinder.
- Blankets should not be ironed.

**6.4 Practices not recommended**

- Worn polycotton sheets (cotton worn away) : uneven finish look when folded, high static electricity.
- Large cotton or flax-made sheets > 200 g/m<sup>2</sup>.

**6.5 Cautions**

- Prepare the large sheets before feeding.
- Avoid the torn, worn or holed sheets, that may hook and alter the measurements and the longitudinal folding.
- Comply with the mini-maxi sizes of sheets.

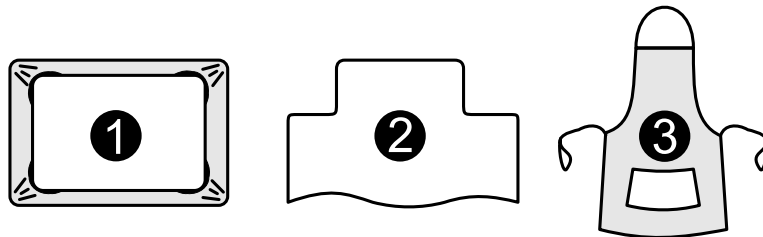

- 1 : Fitted sheet
- 2 : Comforter cases with flap
- 3: Butcher's apron

	Draw-sheets	Fitted-sheets	Comforter cases	Butcher's apron	Linen < 200g/m <sup>2</sup>	Linen > 200g/m <sup>2</sup>
Flatwork ironer	Yes	Yes	Yes	Cautions	Yes	Cautions

**6.6 Using the handle**

The dryer ironer is fitted with a handle.

This is very useful to take out the washing if there is a power failure while you are ironing; or you can use it to feed a piece of wet washing to protect the ironing bands when the ironing temperature is too high.

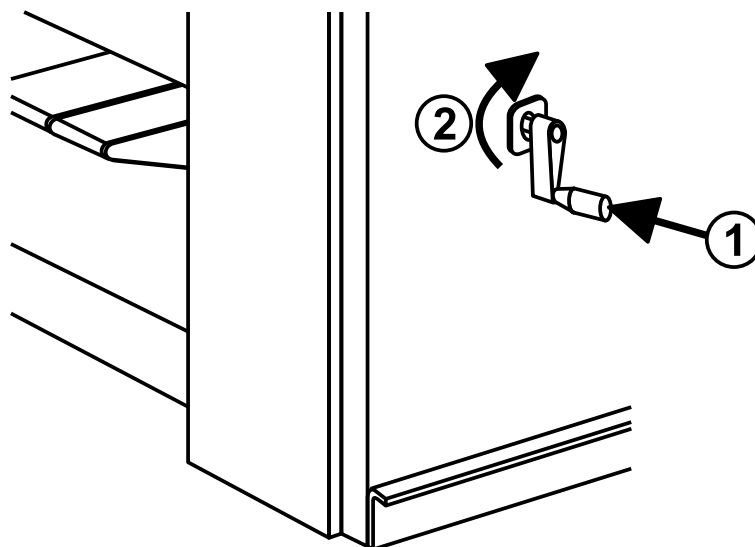

## 6.7 Using the tipping feed bin

The dryer-ironer is equipped with a tipping feed bin. This is very useful for letting large items hang to assist feeding and allow smoothing of linen by hand.

For ease of opening, lift the bin slightly before pivoting.

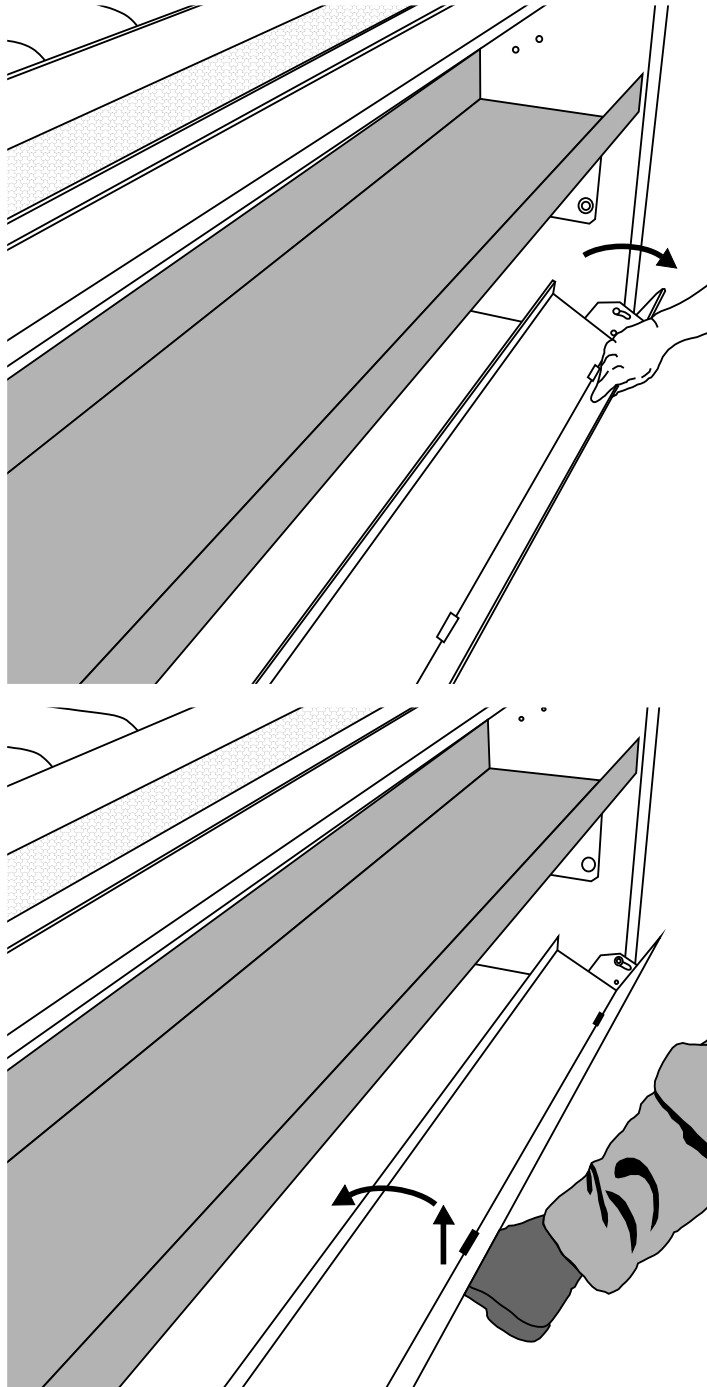

## 7 Use recommendations

- Make sure that the fabric can be ironed, and check which temperature should be used.
- Take care with synthetic and printed fabrics as these can melt and stick to the tray.
- It is advisable to commence ironing with the most delicate fabrics finishing off with the most heat-resistant ones, by progressively increasing the temperature with the thermostat button.
- When ironing small articles, use the entire width of the cylinder so that heat is evenly distributed, preventing wear on only one side of the covering.
- Iron starched articles last, to prevent any eventual residue on the bed from damaging other items.
- Do not iron overly thick linen or covers.

- Do not iron non heat-resistant or overly voluminous buttons (round buttons, for example).
- Carefully inserting the articles to be ironed will improve results.
- Make sure that the width of the ironing does not exceed the useful width of the machine.
- When ironing small items, be sure to alternatively use the full width of the roller (and not simply the middle); this prevents depressions from forming in the middle of the covering. This can effect the quality of the ironing (see figure below).
- When ironing is finished, let the cylinder turn for a few minutes to allow for the evaporation of any humidity absorbed during ironing.
- Let the bed move back before turning off the machine.

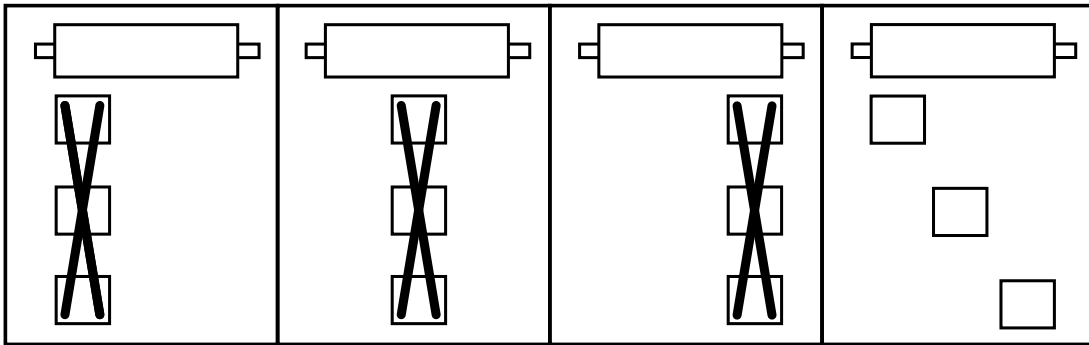

### Important



It is very important that the machine is not running cold, the grip between the cylinder and the chest is too important which can prematurely wear out the cylinder padding and deteriorate the free wheel. Failure to follow this recommendation would void the warranty of the parts in question.  
The outer padding being a consumable, it is normal to replace it periodically.

## 8 Safety devices

- Feed safety system** The space between the feed safety flap and the drive bands is too small for you to enter your fingers. The machine stops automatically as soon as the flap is pushed in.
- Protection of motors** The motors have overload protection :  
  - by thermomagnetic circuit breakers and
  - by the electrical selector (for movement).
- Restarting the machine** After each stoppage of the machine, power cut, emergency stop, or activation of the feed safety, it will then be possible to start again:  
  - in the case of a machine with a standard console, only after pressing the green button of the panel;
  - in the case of a machine with a DIAMMS console, only after pressing one of the buttons of the control panel.
- Gas heating** The gas burner is ignited and the flame is controlled by an electronic box that provides integral safety, for example if the flue draft is poor or if the gas supply is cut off.  
If you have a DIAMMS console, a flashing message on the control panel signals that the system has been set to safe.  
If you have a standard console, the orange lamp signals that the system has been set to safe. If this lamp flashes this signals that the machine has overheated.  
A pressure switch connected to the combustion products outlet turns off the machine's heating function should extraction problems arise.
- Accessibility** Housings can only be dismantled with a special tool.
- Heating safety device** The control panel applies an initial safety level at the time the machine starts up.  
In the case of a DIAMMS console, if the temperature has not been reached after a preset time the heating order is then interrupted.  
Similarly, in the case of a DIAMMS console, operation of heating is conditional on the cylinder rotating. If for any reason whatever the cylinder stops, heating of the machine stops.  
A safety thermostat, which is independent of all electronic systems, limits the heating temperature of the ironing cylinder in all circumstances (except in the case of a steam heating machine).

<b>Power supply failure</b>	If there is a mains power supply failure, use the handle to remove any washing engaged in the machine. If the temperature is too high, use the handle to feed some wet washing and protect the ironing bands.
<b>Ironing Temperature Display</b>	The control enclosure includes an electronic thermostat panel which shows in real time the temperature of the ironing cylinder. A running temperature over the selected temperature is normal. This happening is not a failure of measuring devices but it is due to heating inertia. In automatic mode, temperature and speed management are handled by the machine itself.
<b>Fire-related risks.</b>	Should a fire breakout inside the machine, it is recommended that you use a CO2 extinguisher. <b>Note</b> : in the case of a machine using gas heating, it is <b>strictly forbidden</b> to attempt to put out the fire before having first turned off the gas inlet valve. The client must ensure conformity towards the Labour Code and his supplier of fire-fighting equipment who issues the Q4 certificate to him.
<b>Repair and maintenance work on the machine.</b>	All work on the machine must be carried out by qualified personnel, able to carry out the work required. Ensure that the applicable safety conditions for the destination country are fully observed.



## SAFETY INFORMATION

**Make sure that the protection casings are in position before use.**

### 8.1 Complementary instructions for operation

Check daily that the hand safety bar is working correctly, the machine must stop when you press it. The screen on control panel displays "Emergency Stop/ Reset Push Button". Press any key to resume ironing.

## 9 Operating faults

Encountered problem	Cause of problem	Solution
<b>The linen remains stuck to the cylinder</b>	Your washing is not rinsed correctly If the washing is insufficiently rinsed. Check that ironer separating ribbons are intact. Check the cylinder temperature. The washing is not sufficiently spun.  Your linen is starched	Check rinsing with a 1 % phenolphthalein solution diluted in alcohol. If this colorless liquid turns to pink on the washing as it comes out of the washing machine, and it still contains detergents. Increase the number of rinsings if necessary or reduce product doses. There is a risk of starch deposits forming on the cylinder
<b>When the linen comes off the dryer-ironer it is not dry</b>	Your washer-spin dryer has a spin rating of below 300G.  Check the drying quality of your washing machine.  The ironing speed is too high. The ironing temperature is too low. The linen that you are trying to iron is too thick. Check operation of the heating. Check operation and cleanliness of the vacuum intake system. Check the condition of ironing bands (fibers containing scale). Check the pressure of the ironing roller on the ironing cylinder.	You should plan on a short pre-drying session in a dryer (5 – 10 mins). The residual moisture content of the washing should be about 50 %. Reduce the ironing speed.



<p><b>The heating does not work, or works badly</b></p>	<p>Check the temperature preselection.                  Check the safety thermostat.                  Check to see if the panel is showing over-heating or a high temperature.                  Check the cylinder's rotation detection system.                  Gas heating                  Check the gas inlet.                  Clean pressure reducer filters.                  Check electronic ignition.                  Check the position of the ignition electrodes and flame control. Check operation of the gas solenoid valve.                  The flame is yellow Electrical heating                  Check heating contacts KM6, KM7 and KM8.                  Check heating resistances.                  Check resistance connections.                  Check phases.</p>	<p>Check the panel's sensors                  Check that the vapour intake fan is working and is turning in the right direction.                  Check that air inlets are not blocked.                  Check the combustion products exhaust flue.                  Check injector calibration.                  Clean machine air inlet filters.</p>
<p><b>The machine temperature drops</b></p>	<p>Check the sensor in the thermostat regulation system.                  Check the thermostat by measuring the cylinder temperature with a thermometer.                  Check that the regulation shoe is in contact with the cylinder.</p>	
<p><b>The machine stops suddenly</b></p>	<p>Check the electric power supply.                  Check the hand safety flap switches S5 and S6.                  Check the movement and ventilation fans.                  Check circuit breakers.</p>	

### 9.1 Static electricity

- Synthetic textiles are used increasingly in laundry. The low rate of relative moisture on output from drying allows high ironing speeds, which leads to production of harmful static electricity when the linen is ironed in the machine.
- Any friction generates static electricity. Remember the plastic ruler people rub over their pullover to attract little bits of paper. With the same causes producing the same effects, the linen being subjected to friction in the course of ironing, the rubbing of the linen against the cylinder generates static electricity. If too much static electricity builds up, friction has to be reduced, which can be done by removing the driving chain of the press-cylinder to reduce the generation of static electricity.

### 9.2 Linen colouring

- The brown coloring is due to detergent residues, and will disappear at the next washing.
- Colouring caused by the temperature being too high is permanent. Reduce the ironing temperature or increase the ironing speed.
- The washing should be correctly rinsed so that it does not turn yellow and does not make the cylinder dirty.
  - Check the quality of the washing water (TH/TAC).
  - Check the washing and rinsing cycles (see "phenolphthalein" operating incidents).
  - Check incrustation of the washing (ash content).

### 9.3 The feed bands are not turning

- This type of incident is normal when it only affects a few bands. When washing will not engage any more, adjust the tension of all the bands by changing the setting of the feed table.  
 Do not overtighten the bands.  
 The band must stop turning when you press on it with your finger. It must start again when you remove your finger.

### 9.4 Complementary instructions for starting up a machine with gas heating.

The message "Error Gas Ignition" is flashing on display screen during 30 seconds to show that the gas burner is being ignited. If this message is still displayed after 6 seconds, there may be an ignition fault, a failure in gas valve opening or a lack of gas.

Switch the machine off and call your local repairman if this occurs regularly.

About 12 minutes is necessary to warm up.

**Note:** Do not forget to open the stop valve on the gas supply line before starting to use the machine, and then close it again after use.

The noise at the inter-ignition is not an explosion. It is a normal phenomenon.

### 9.5 Overheating of cylinder sides

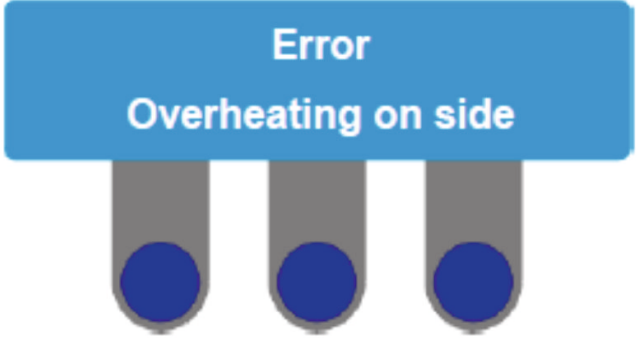
	<p><b>Overheating of cylinder sides (when feeding is carried out on the centre of the cylinder too often)</b></p> <p>In the event that one of the two sides of the cylinder overheats due to it being partially used, a flashing message will be displayed on the screen, alternately with the service screen.</p> <p>The heating system of the machine will remain shut down while this flashing message is displayed. To continue ironing, allow the cylinder to cool until the flashing display disappears.</p>
--	--

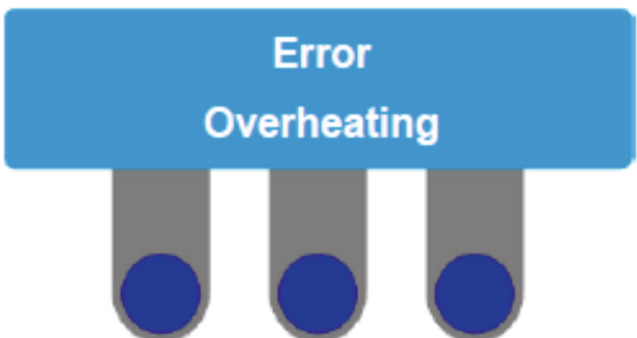

### 9.6 Overheating of centre of cylinder

	<p><b>Overheating of centre of cylinder (when small linen units are too often fed on the centre of the cylinder)</b></p> <p>In the event that the centre of the cylinder overheats due to it being used laterally, a flashing message will be displayed on the screen alternately with the operating screen.</p> <p>The heating system of the machine will remain shut down while this message continues to be displayed.</p> <p>To continue ironing, allow the cylinder to cool until the flashing display disappears.</p>
---	---

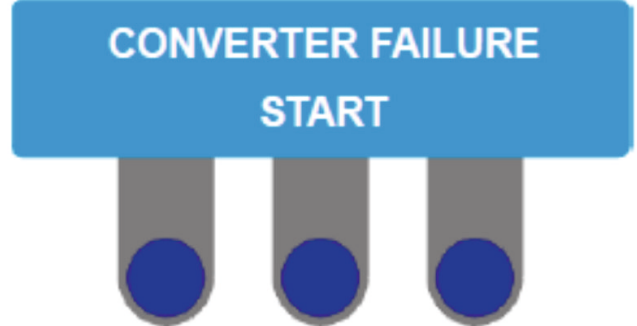
### 9.7 Converter fault

	<p><b>"Converter failure" message</b></p> <p>If this message appears on the screen, the converter has developed a fault.</p> <p>Please refer to the converter manual for information repairing the fault. The machine will only be able to be restarted once the fault has been repaired.</p> <p>To reinitialise the machine, press the central key.</p> <p>If the fault remains, switch off then switch back on the power supply using the main switch.</p>
--	--

## 9.8 Fault Emergency stop

	<p><b>Message: «Emergency stop-check button»</b>          If the screen displays this message, one of the emergency stop buttons has been triggered. The machine enters safety mode, the heating is turned off and the cylinder stops.          Check why the button was pressed and then reset it. The screen should now display this message :</p>  <p>You can now press the central button on the panel to return to the machine operation mode.          If resetting the button does not solve the problem, you should then check the others.</p>
---	--

## 9.9 Gas burner ignition fault (only for machines using gas heating)

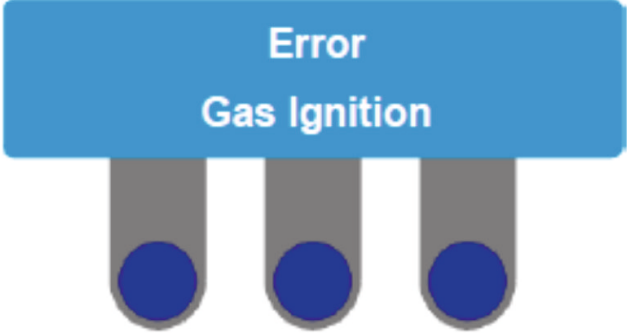
	<p><b>"Gas ignition fault" message (only on gas-heated machines).</b>          The screen will alternately display this flashing message and the service screen.          This means that the lighting of the gas burners has been requested. If this message has been displayed over 30 seconds, the gas burner is not ignited.          The heating system falls into safety state and heating is cut off. Try again and follow the starting procedure.          Press any key to display the following menu.          After an additional failure, please check the gas heating running. If the fault remains, consult your after-sales service.</p>
--	---

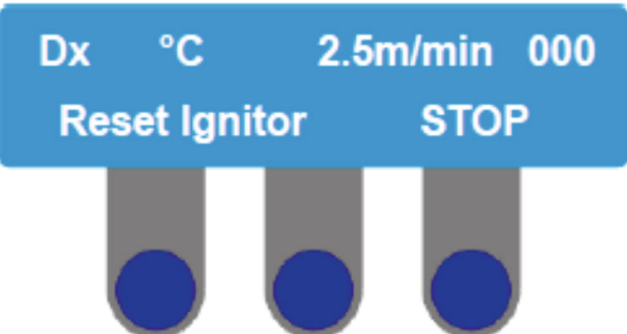

## 9.10 Reset the igniter (only for machines using gas heating)

	<p><b>Message: «Reset igniter».</b>          The message on the screen will then ask you if you wish to reset the igniter.          Press on one of the two buttons on the left to restart the gas igniter. Press the «STOP» button to stop the machine.</p>
---	--

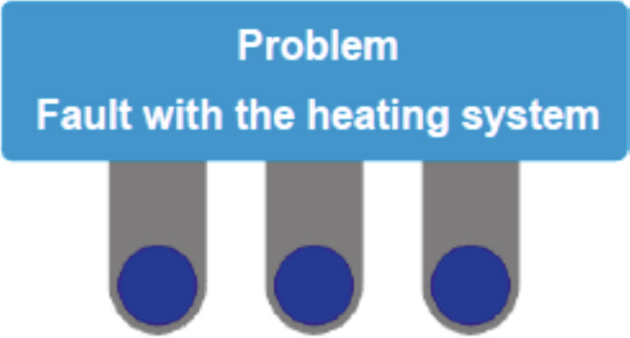

### 9.11 Fault with the heating system

	<p><b>Message: «Problem - fault with the heating system».</b>          The screen appears if, after a certain time (approximately 20 minutes) the cylinder temperature remains below 100°C (212 °F).          Try to restart the machine.          If the problem continues, please consult your after-sales service department.</p>
---	--

## 10 Maintenance

	<p><b>Caution</b></p> <p>SHUT OFF THE POWER SUPPLY OF THE MACHINE BEFORE ANY MAINTENANCE OR REPAIR INTERVENTION IS CARRIED OUT AND MAKE SURE THAT THE CYLINDER IS COLD.          To get the best results and optimum safety from your machine, observe all the servicing instructions.</p>	
--	--	---

	<p><b>SAFETY INFORMATION</b></p> <p>Any repairing or maintenance operation should be carried out by a specialist.</p>
--	---

	<p><b>Caution</b></p> <p>For an optimal service of your machine, execute this instructions at regular intervals and according to the frequency of use.</p>	
--	--	---

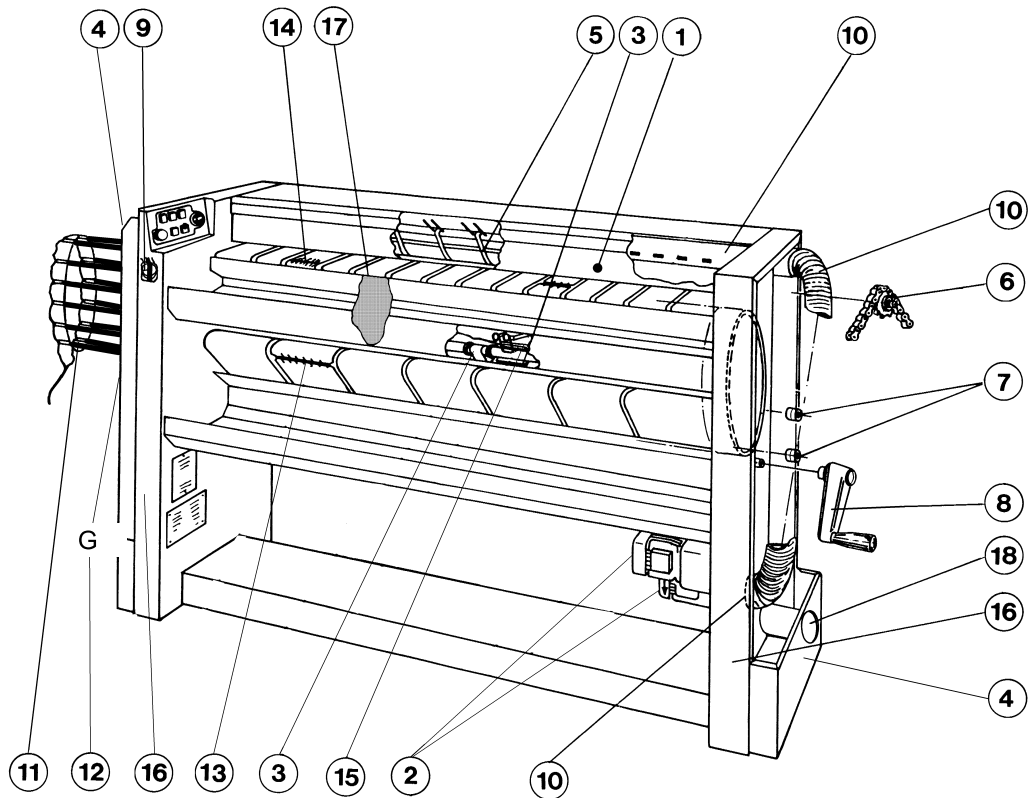

#### Each day (8h)

- 1. Check that the finger protection is working.

#### Every week (40h)

- 2. Clean the fan grates of motors.
- 3. Clean the stripper fingers and the thermostat attachment.
- 4. Clean the ironer external, from dust.
- G. Clean the fluff filter with suction device.
- G. Clean the cover filter with suction device.

#### Every month (170h)

- 5. Check that the parting strips are intact and replace if necessary.

#### Every 6 months (100h)

- 6. Slightly grease the chains (see lubrication table in the handbook).
- 7. Clean and check the support rollers of the cylinder.
- 8. Check that the crank is working.
- 9. Check that the electrical connections are shut off on the supply terminal.
- 10. Clean the whole suction device.
- 11. Check the heating elements, wires and connections (only for electric heated machines).
- 12. Clean the gas filters (only for gas heated machines).
- 13. Check the condition and tension of the ironing strips and of the clips.
- 14. Check the feeding bands, their drive and the clamps.
- 15. Check that the thermostat is working.
- 16. Clean the ironer internal, from dust.

#### Every year (2000h)

- 17. Check if the cylinder has any deposits of detergent or lime. Clean if necessary.
- 18. Check and clean the outer pipes.
- G. Clean the fluff filter with suction device.

- G. Clean the cover filter with suction device.
- G. Clean the inner gas burner with suction device.
- G. Check the sight of the ceramic plates joints and change them if necessary.

#### Every 3 years (6000h)

- G. Clean the fluff filter with suction device.
- G. Clean the cover filter with suction device.
- G. Clean the ceramic plates with suction device.
- G. Change the high temperature joints made of mineral wool.
- G. Check the tightness of the venturis.

### 10.1 Check of the detaching cords or pressure roller :

It is necessary to lift up the upper casing of the machine.

Proceed as follows :

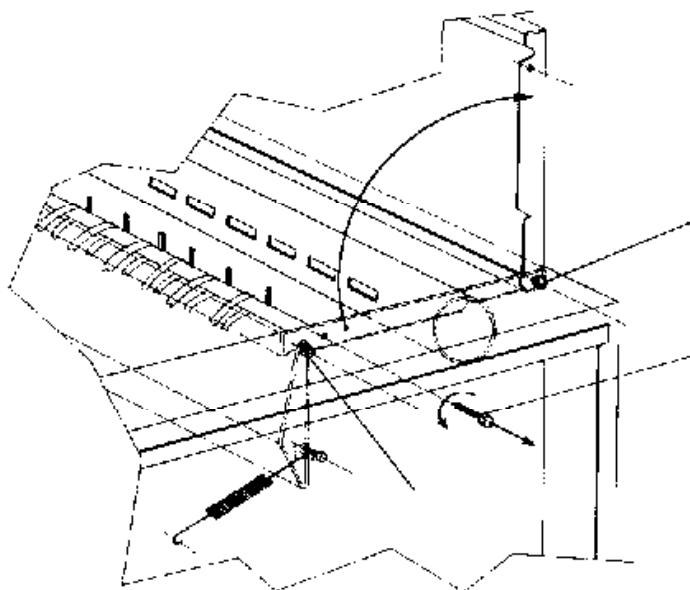

1. Stop the machine.
2. Dismantle the side casing with the key.
3. Do not touch the screws (A) which serve as a link with the casing, a screw in each cais-son.
4. Unscrew and remove the scews (B). **Careful** : do not touch the screws (C) which are used for the joint of the finger protection device.

Now you can lift up the upper casing in order to access to the detaching cords.

After the intervention, hinge the upper casing down, reset and tighten the screws, then reassemble the side casings.

### 10.2 Replacing ironing bands

1. Stop the machine.
2. Remove the feed tray to obtain easy access to the ironing bands.
3. Remove staples from the two ends of the bands to be replaced and staple the end of the old band with the end of the new band.
4. Rotate the cylinder using the handle.
5. Unstaple the ends of the old and the new band, and staple the two ends of the new band together.
6. Do the same for the other bands.
7. Replace the feed tray.



### Caution



The tension of the ironing bands was adjusted in the factory with the machine hot. Never retension the bands. Their tension must be as low as possible (just enough to drive them) since excessive tension will cause fast wear of these bands.  
Remember these comments if you need to make an adjustment or a replacement.

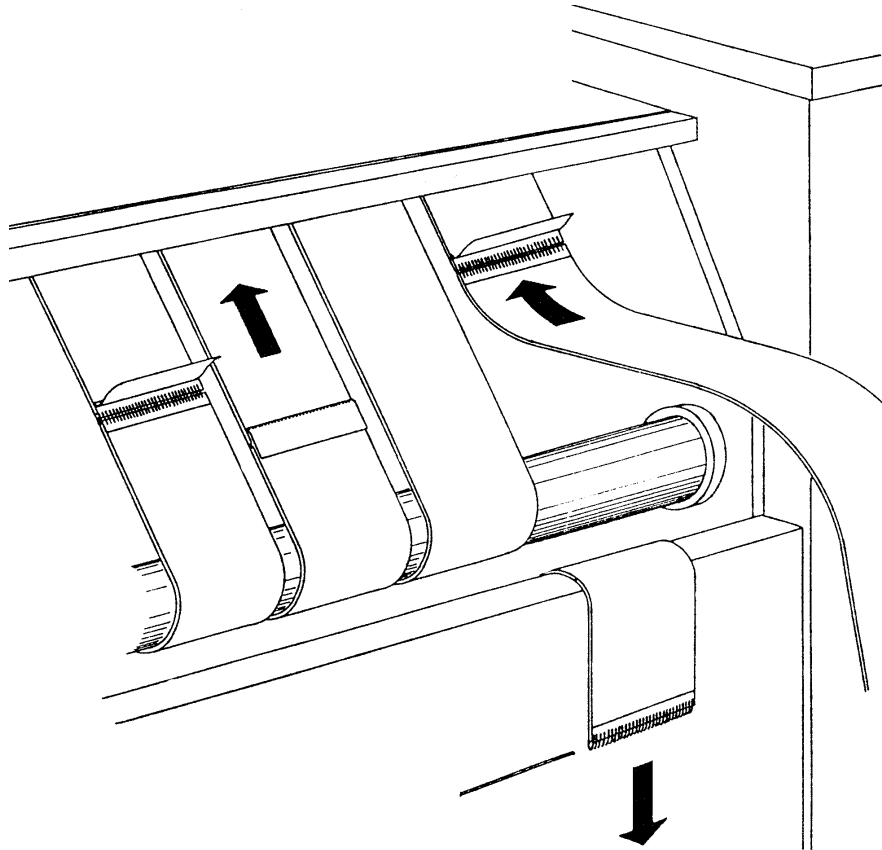

## 10.3 Components with maintenance

### Motors :

The fan motor is permanently lubricated.

The movement motor is permanently lubricated.

### Bearings :

Permanently lubricated.

### Heat control :

Make sure that the shoe of the thermostatic control and the safety control devices are always clean and in cylinder contact.

### Gas heating :

Check annually the good working of the burner (removal and blowing).

Check and clean the lint filter regularly.

### Cylinder :

The cylinder must be kept very clean to make ironing easier and must be of a very high quality.

Deposits of washing powder or lime must be removed as soon as they start to affect the quality of the ironing.

The use of VERY FINE saddle grinder ONLY is recommended (grain 180 or Scotch Brite 3M BFB-AM).

**THIS SHOULD BE RUBBED IN THE SAME DIRECTION AS THE LINEN IS PASSED THROUGH THE MACHINE.**





Should the machine be stopped for a long period, in order to avoid any oxidation of the cylinder, a sheet impregnated with paraffin wax should be fed through the machine.

Using an old sheet, grate a little paraffin wax onto half of the unfolded sheet, fold in half and then run it through the flatwork-ironer while it is still hot enough.

If the machine is to be left unused for a longer period, it is advisable to oil the cylinder slightly (anti-rust oil ref. 96010012).

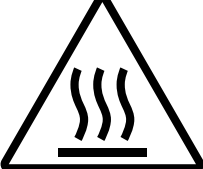
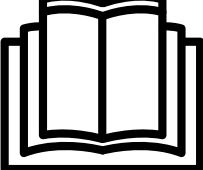

## 11 Symbols

	<p>Caution. An exclamation mark inside an equilateral triangle offers the user important advice about usage, servicing and hazardous conditions.</p>
	<p>Caution, presence of dangerous current. A flash of lightning with an arrow at its end displayed inside an equilateral triangle, warns the user about the presence of uninsulated "dangerous current" sufficient in intensity to cause electrocution.</p>
	<p>Caution, hot surface. This symbol warns the user of the presence of high temperatures which could cause severe burns. Some surfaces can reach close to 200 °C (392 °F).</p>
	<p>Read the instructions before using the machine.</p>
	<p>Warning, do not operate with casing removed. This symbol warns the user that there are mechanisms inside the machine which can be dangerous. The protective housing must be in place during use.</p>

## 12 Lubricant table

MACHINE LUBRICATION								
USES	Rolling bearings Bearings	Rolling bearings Bearings high temperature	Assembly paste (fretting corrosion)	Bare gears Chains shafts Thread Slides	Flange joints Union pipes Steam circuits	Reducers with wheels and screws	Reducers with gears	Circuits and pneumatic devices
TYPES OF LUBRICANTS AND STANDARDIZATION	Lithium soap grease	Lithium soap grease + silicone oil	Lithium soap paste + mineral oil + mineral solid greases	Lithium soap grease with MOS2 additive	Graphite grease mini 60% graphite, special leakproof	Extreme high pressure oil	Extreme high pressure oil	Inhibited oil SAE5
	Grade ISO NLGI2	Grade ISO NLGI3	Grade ISO NLGI1	Grade ISO NLGI2	Grade ISO NLGI2	Grade ISO VG150	Grade ISO VG220	Grade ISO VG22
TEMPERATURE LIMIT RANGE	-20°C + 140°C -4°F + 284°F	-40°C + 200°C -40°F + 392°F	-20°C + 150°C -4°F + 302°F	-20°C + 135°C -4°F + 275°F	-30°C + 700°C -22°F + 1292°F	-0°C + 100°C -32°F + 212°F	-20°C + 120°C -32°F + 248°F	+10°C + 65°C +50°F + 149°F
RECOMMENDED	CELTIA G2	NTN SH44 M	ALTEMP Q NB 50	MI-SETRAL 43N	GRACO AF 309	REDUCTELF SP150	REDUCTELF SP200	LUBRAK ATL SAE 5W
PRODUCT CODE	96 011 011	96 011 019	96 011 014	96 011 000	96 011 004	96 010 001	96 010 004	96 010 030
CORRESPONDENCE								
ANTAR	ROLEXA 2			EPOXA MO2		EPONA Z150	EPONA Z220	MISOLA AH
BP	LS EP2					ENERGOL CRXP150	ENERGOL CRXP220	SHF 22
CASTROL	SPEEROL EP2					ALPHA SP150	ALPHA SP220	
ELF	EP2			STATERMA MO10		REDUCTELF SP150	REDUCTELF SP220	SPINEF 22
ESSO	BEACON EP2			MULTI PURPOSE GREASE MOLY		SPARTAN EP150	SPARTAN EP220	SPINESSO 22
FINA	MARSON EP2					GIRAN SR150	GIRAN SR220	
GBSA					BELLEVILLE N			
GRAFOIL					GRACO AF309			
KLUBER	CENTOPLEX 2	UNISILKON L50Z	ALTEMP Q. NB50	UNIMOLY GL82	WOLFRA-COAT C	LAMORA 150	LAMORA 220	CRUCOLAN 22
MOBIL	MOBILUX					MOBILGEAR 629	MOBILGEAR 630	DTE 24
KERNITE	LUBRA KLC			LUBRA KMP		TOP BLENB ISO 80W90	TOP BLENB ISO 220	LUBRA K ATL SAE5W
SETRAL				MISETRAL 43N				
SHELL	ALVANIA R2			RETINA AM		OMALA 150	OMALA 220	TELLUS 22
TOTAL	MULTISS EP2					CARTER AP150	CARTER EP220	EQUIVIS 22
MOLYKOTE		MOLYKOTE 44	PATE DX					
OPAL	GERVAIR SP			SUPER MOS2		GEAROPAL GM65 ISO 150	GEAROPAL GM75 SO 220	HYDROPAL HO110 HM+ +22
ITECMA	GRL-ULTRA	VULCAIN	SILUB-P	GMO	LHT-C	DURAGEAR BL	DURAGEAR BL	AEROSYN
DOW CORNING		SH 44M						

To lubricate door mechanism of WSB5, use reference 96010068 Loctite LB 8001.















## 13 Explanation of washing symbols

(ISO 3758:2005 standard)

To overcome language barriers, the following are symbols used internationally to give you guidance and recommendations when washing different textiles.



### 13.1 Washing

The tub symbolizes washing.

Symbols	Max. washing temperature in °C ( °F)	Mechanical action
	95 (203)	normal
	95 (203)	mild
	70 (158)	normal
	60 (140)	normal
	60 (140)	mild
	50 (122)	normal
	50 (122)	mild
	40 (104)	normal
	40 (104)	mild
	40 (104)	very mild
	30 (86)	normal
	30 (86)	mild
	30 (86)	very mild
	40 (104)	wash by hand
	-	do not wash



### 13.2 Bleaching

The triangle symbolizes bleaching.

Symbols	Explanation
	Bleaching allowed (chlorine or oxygen).
	Bleaching allowed (only oxygen).
	Do not bleach.





### 13.3 Drying

The circle in a square symbolizes tumble drying.

Symbols	Explanation
	Can be put in a tumble dryer. Normal temperature.
	Can be put in a tumble dryer. Lower temperature.
	Do not put in a tumble dryer.



### 13.4 Ironing

The iron symbolizes the domestic ironing and pressing process.





Symbols	Explanation
	Max. temperature 200 °C.
	Max. temperature 150 °C.
	Max. temperature 110 °C. The steam can cause irreversible damages.
	Do not iron.

### 13.5 Dry or water cleaning

The circle symbolizes dry or water cleaning.

Symbols	Explanation
	Normal dry cleaning with perchloroethyl, solvent of hydrocarb.
	Mild dry cleaning with perchloroethyl, solvent of hydrocarb.
	Normal dry cleaning with solvent of hydrocarbon.

---

	Mild dry cleaning with solvent of hydrocarbon.
	Do not dry clean.
	Normal water cleaning.
	Mild water cleaning.
	Very mild water cleaning.







Electrolux Professional AB  
341 80 Ljungby, Sweden  
[www.electroluxprofessional.com](http://www.electroluxprofessional.com)